

INSTRUCTION PAPER

METRIS | Dining table 160x160

DIPHANO
OUTDOOR FURNITURE

Start by unpacking everything carefully. Make sure to cover the floor to prevent any damage or scratching (you can use the cardboard box for this).

CONTENT

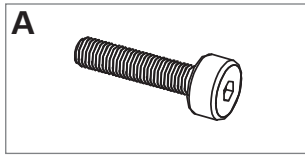

10x bolt (M8x40mm)

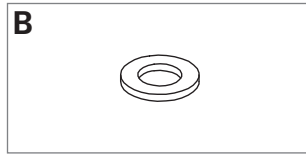

10x washer (M8)

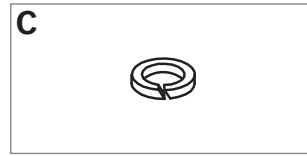

10x spring washer (M8)

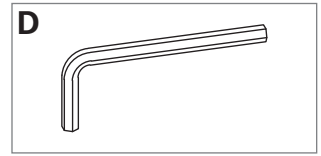

1x hex key (6)

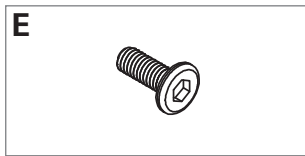

4x bolt (M6x15mm)

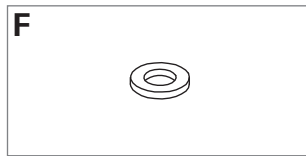

4x washer (M6)

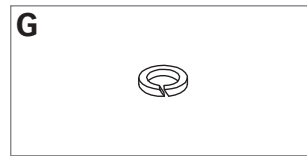

4x spring washer (M6)

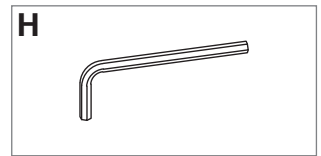

1x hex key (5)

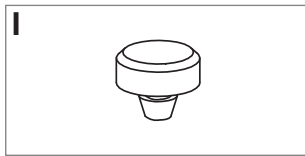

20x bumper (5mm)

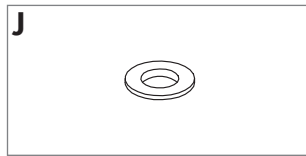

20x washer (1mm)

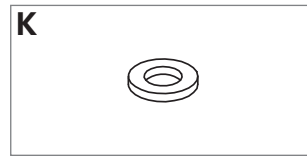

20x washer (2mm)

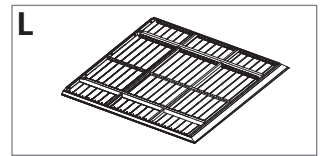

1x alu table top support

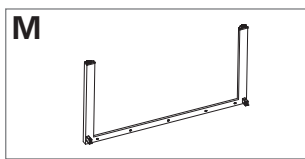

2x alu legs

STEP 1: ASSEMBLE ALUMINIUM LEGS

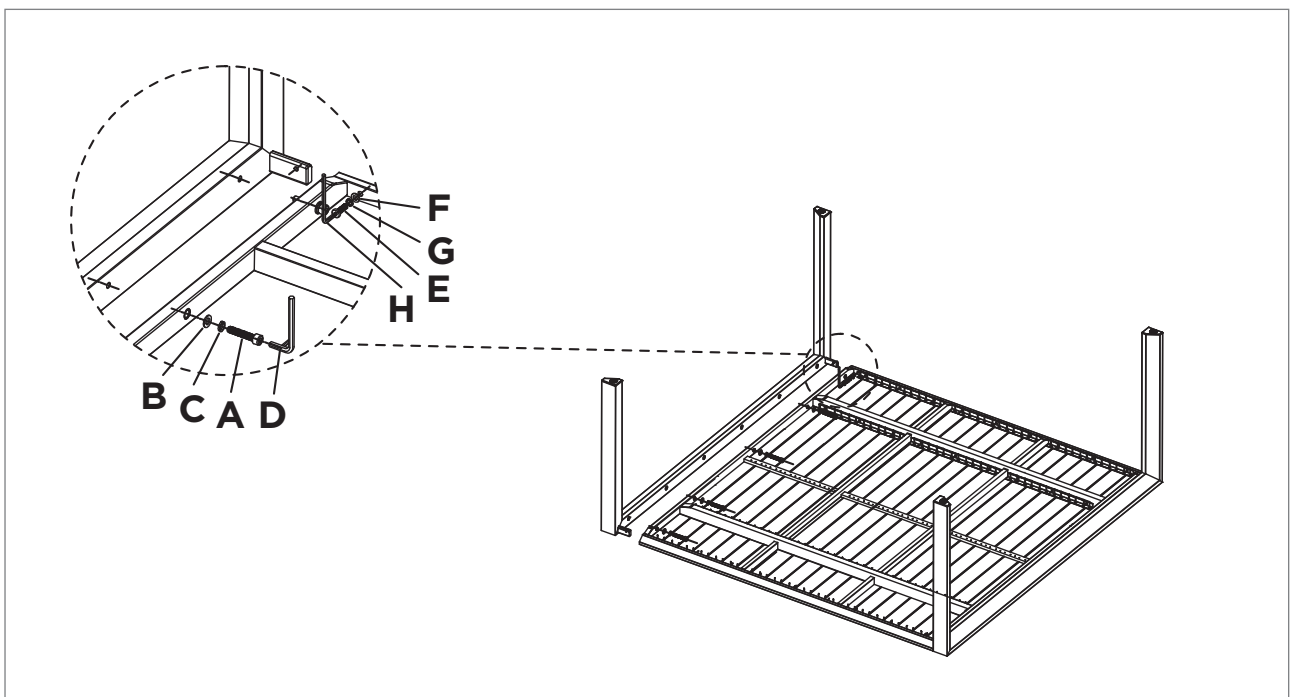

Use the hex keys (D,H) to screw the the aluminium legs onto the table top (L) as shown in the picture. Make sure you follow the correct order as indicated by the letters in the picture. Repeat this action for the other side.

INSTRUCTION PAPER

METRIS | Dining table 160x160

DIPHANO

OUTDOOR FURNITURE

STEP 2: TURN TABLE

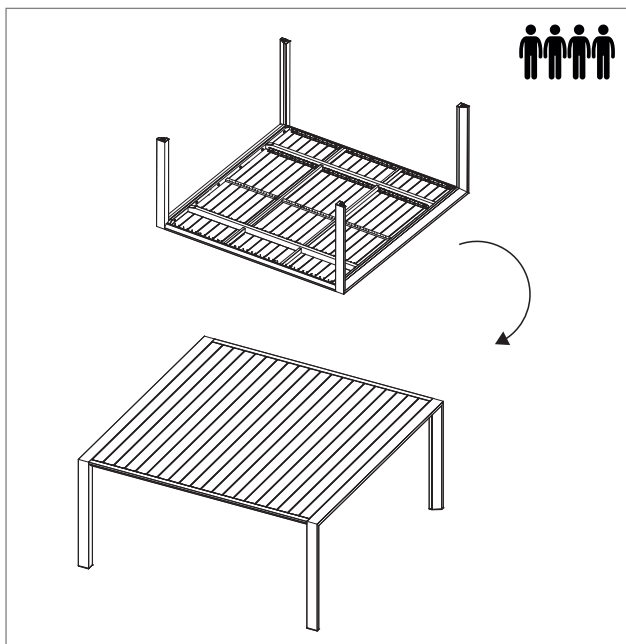

Turn the table carefully to its normal position with at least 4 persons.

STEP 3: ADJUST FEET

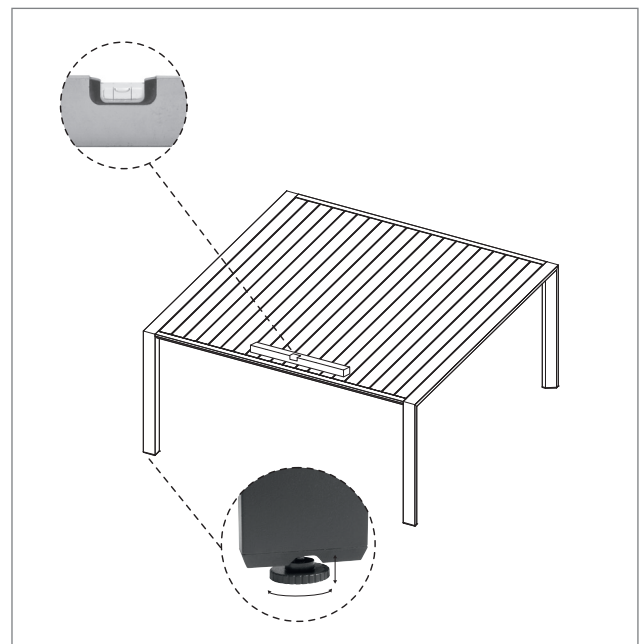

Check with a spirit level if the table is placed level. If not, (un)screw the adjustable feet till your table is completely level.



DINING
ARMCHAIR

BARSTOOLS
78 | 62h

LOUNGER

BENCHES & LOW TABLES



SIDE TABLE

BISTRO TABLES 108 | 74h

DINING TABLES 92 | 75h

PARTY TABLES 109 | 92h

BAR & BAR TEAK

www.diphano.com

Diphano cannot be held responsible if the assembly instructions are not followed properly.