

DIPHANO



Natural

dining table 215x105

INSTRUCTION MANUAL

how to assemble the dining table

CONTENT

Start by unpacking everything carefully. Make sure to cover the floor to prevent any damage or scratching (you can use the cardboard box for this).

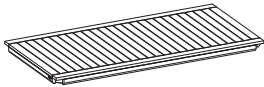

A
1x table top

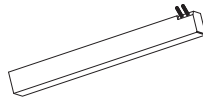

B
4x leg

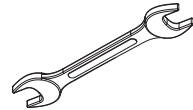

C
1x wrench 17



D
16x nut M10



E
4x washer plate

Diphano cannot be held responsible if the assembly instructions are not followed properly.

1

POSITION THE LEGS

Position the legs (B) onto the table top (A) by inserting the two pins into the pre-made holes.

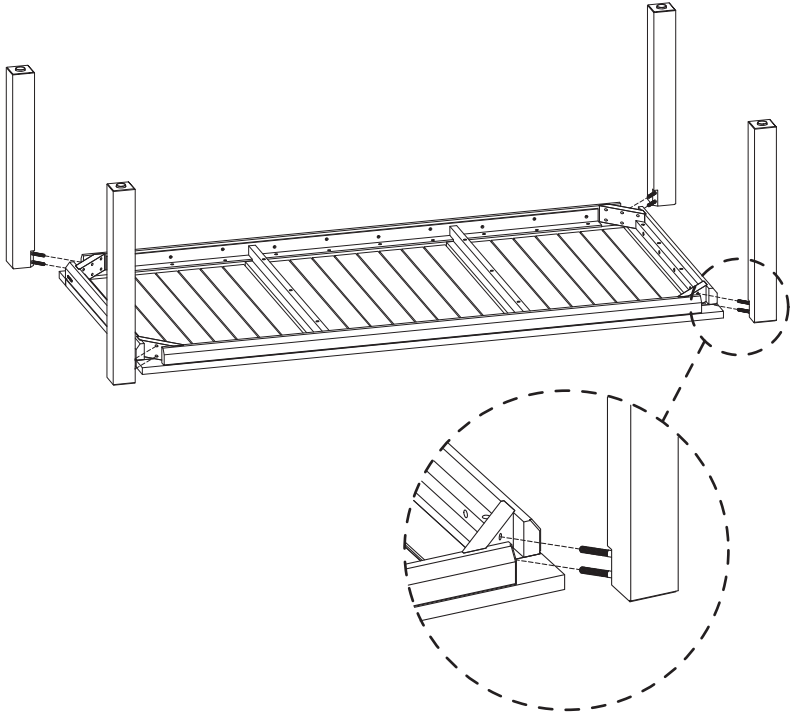

2

CONNECT THE LEGS

Connect the legs (B) to the table top (A). To do this, position the washer plate (E) on the two pins and fixate by screwing the nuts (D) onto the pins, using the wrench key (C).

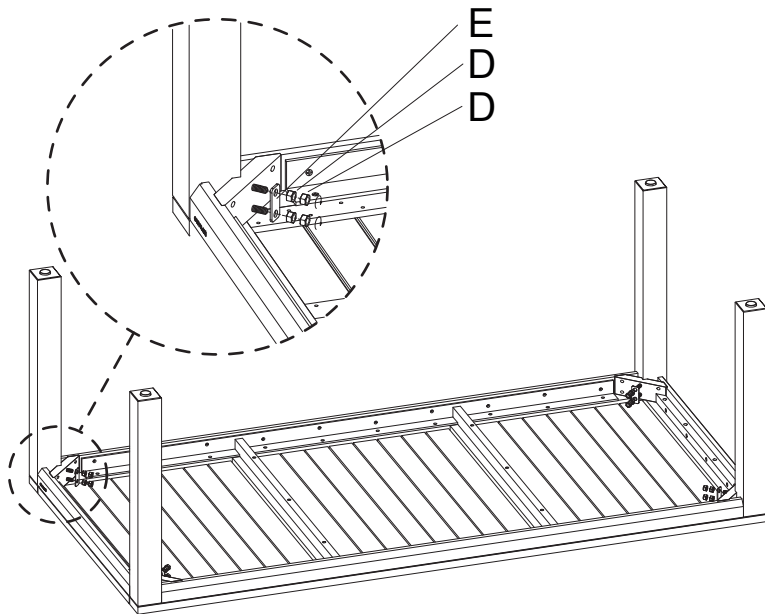

3

TURN TABLE

Turn the table carefully to its normal position with at least 4 people.

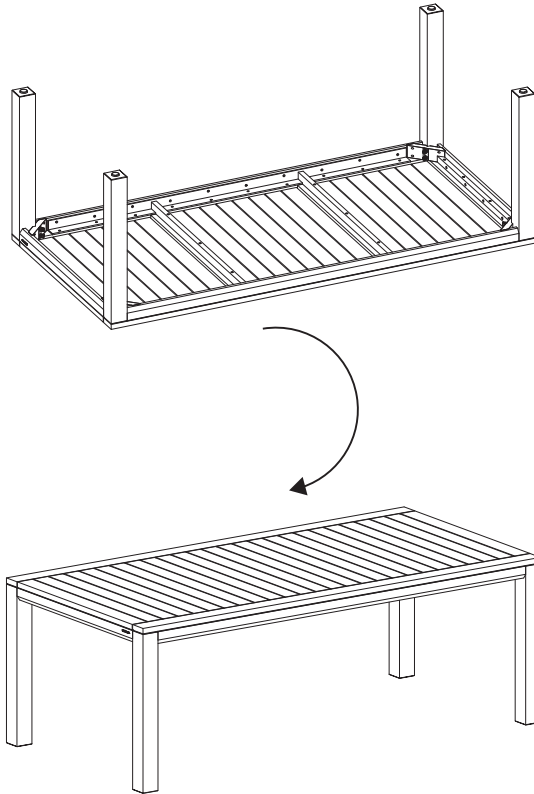

attention

DO NOT PRESSURE CLEAN



DO NOT SIT ON THE TABLE



maintenance & care

NATURAL TEAK

Simply brush away loose dirt, rinse, and clean with a mild, lukewarm soapy solution. Rinse thoroughly and pat dry with a cloth. If the teak is 100% dry and free of dust, you can apply our Teak stain protector to make it repellent to water and moisture. Avoid the use of abrasive products and solvents and high pressure cleaning.



Teak stain protector

Saturates teak to make it repellent to water and moisture. Helps to prevent stains (e.g. wine stains, barbecue stains...). Easy to apply. Transparent finishing.

DIPHANO

OUTDOOR FURNITURE

www.diphano.com

Textielstraat 4 - 8790 Waregem - Belgium
Tel. +32 (0)56 980 008 - info@diphano.com