

DIPHANO



Metris

dining table 226x90

INSTRUCTION MANUAL

assembly instructions

CONTENT

Start by unpacking everything carefully. Make sure to cover the floor to prevent any damage or scratching (you can use the cardboard box for this).

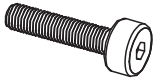

A
8x bolt (M8x40mm)



B
8x washer (M8)



C
8x spring washer (M8)



D
1x hex key (6)



E
4x bolt (M6x15mm)



F
4x washer (M6)



G
4x spring washer (M6)



H
1x hex key (5)



I
1x alu table top



J
2x alu legs

CONNECT ALUMINIUM LEGS

Use the hex keys (D, H) to assemble the aluminium legs (J) onto the table top (I) as shown in the picture. Make sure you follow the correct order as indicated by the letters in the picture. Repeat this action for the other side.

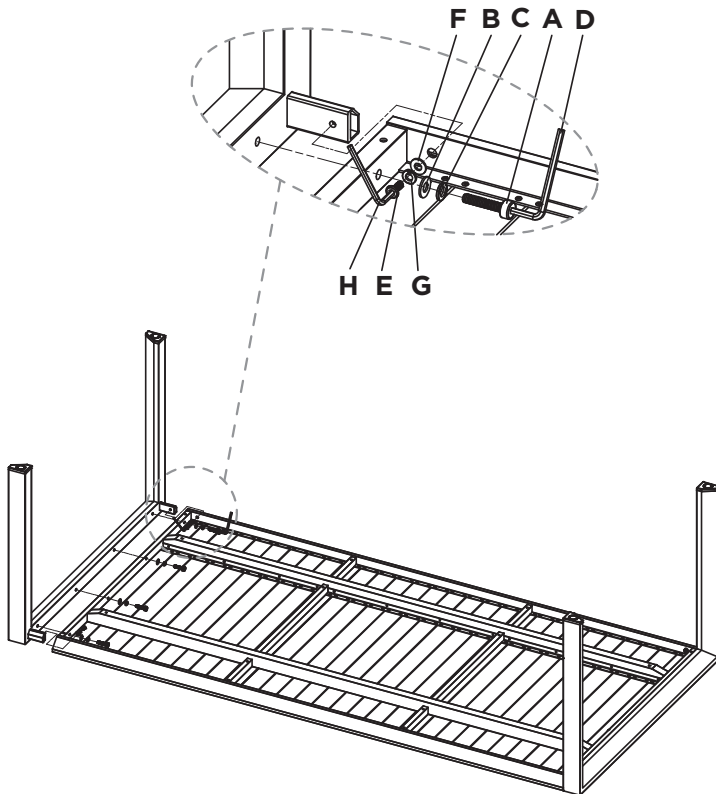

TURN TABLE

Turn the table carefully to its normal position with at least 4 persons.

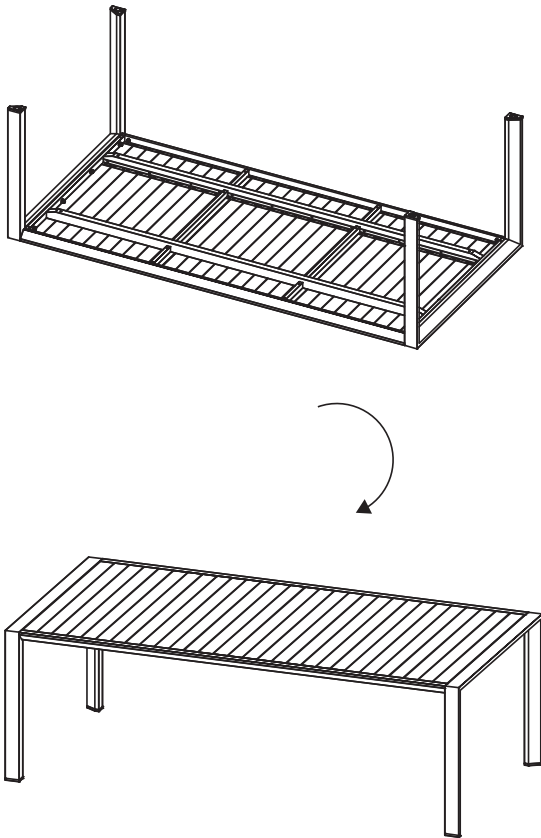

ADJUST FEET

Check with a spirit level if the table is placed level. If not, (un)screw the adjustable feet till your table is completely level.

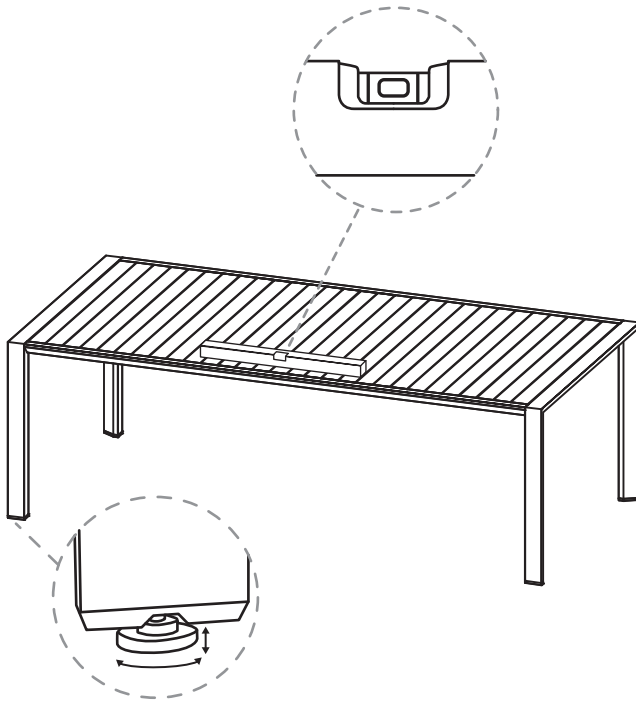

maintenance & care

POWDERCOATED ALUMINIUM

Simply brush away loose dirt, rinse, and clean with a mild, lukewarm soapy solution. Rinse thoroughly and pat dry with a cloth.

DIPHANO

OUTDOOR FURNITURE

www.diphano.com

Textielstraat 4 - 8790 Waregem - Belgium
Tel. +32 (0)56 980 008 - info@diphano.com